

PROGRAMMABLE PERIPHERAL INTERFACE 8255

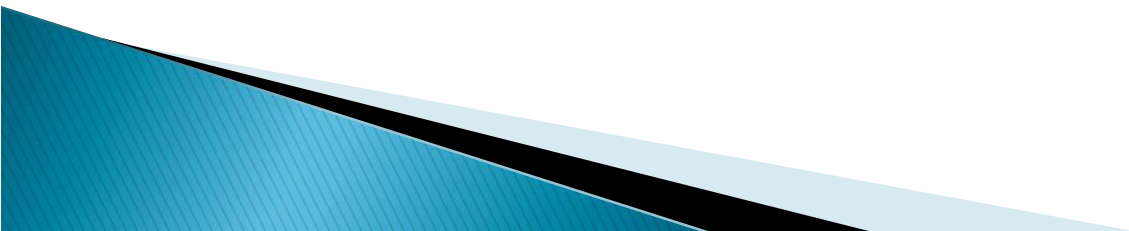
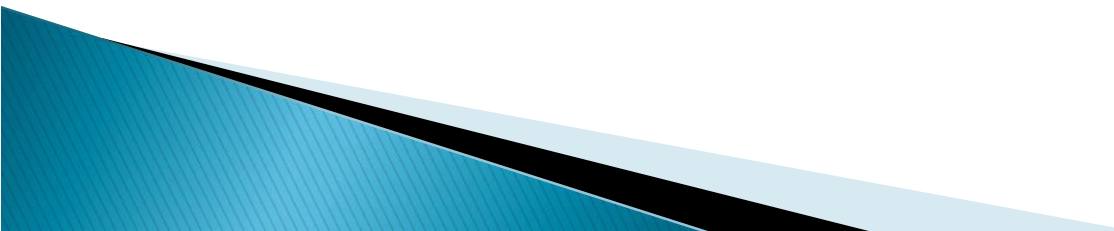

Introduction

- ▶ Peripheral interface are the intermediate devices which is used to communicate between the two devices for example if we connect computer and printer then these two device can not work here we required at least one device that can connect these two devices it could be USART or 8255 programmable peripheral interface.
- 

PROGRAMMABLE PERIPHERAL INTERFACE -8255

Features:

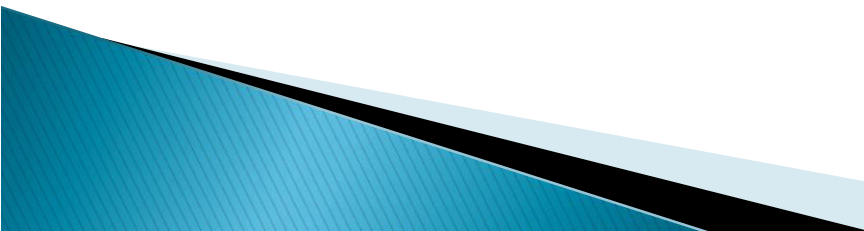
- ▶ **It is a programmable device.**
 - ▶ **It has 24 I/O programmable pins like PA,PB,PC (3-8 pins).**
 - **T T L compatible.**
 - **Improved dc driving capability**
- 

Pin Diagram-8255

PA3	1		40	PA4
PA2	2		39	PA5
PA1	3		38	PA6
PA0	4		37	PA7
\overline{RD}	5		36	\overline{WR}
\overline{CS}	6		35	RESET
gnd	7		34	D0
A1	8		33	D1
A0	9		32	D2
PC7	10	8255	31	D3
PC6	11	PPI	30	D4
PC5	12		29	D5
PC4	13		28	D6
PC0	14		27	D7
PC1	15		26	Vcc
PC2	16		25	PB7
PC3	17		24	PB6
PB0	18		23	PB5
PB1	19		22	PB4
PB2	20		21	PB3

Function of pins:

- ▶ **Data bus(D₀-D₇):** These are 8-bit bi-directional buses, connected to 8085 data bus for transferring data.
- ▶ **$\overline{\text{CS}}$:** This is Active Low signal. When it is low, then data is transfer from 8085.
- ▶ **$\overline{\text{Read}}$:** This is Active Low signal, when it is Low read operation will be start.
- ▶ **$\overline{\text{Write}}$:** This is Active Low signal, when it is Low Write operation will be start.

- ▶ Address (A_0 - A_1): This is used to select the ports. like this

A1	A0	Select
0	0	PA
0	1	PB
1	0	PC
1	1	Control reg.

- ▶ **RESET:** This is used to reset the device. That means clear control registers.
- ▶ **PA₀-PA₇:**It is the 8-bit bi-directional I/O pins used to send the data to peripheral or to receive the data from peripheral.
- ▶ **PB₀-PB₇:**Similar to PA
- ▶ **PC₀-PC₇:**This is also 8-bit bidirectional I/O pins. These lines are divided into two groups.
 1. **PC₀ to PC₃(Lower Groups)**
 2. **PC₄ to PC₇ (Higher groups)**

These two groups working in separately using 4 data's.

Block Diagram

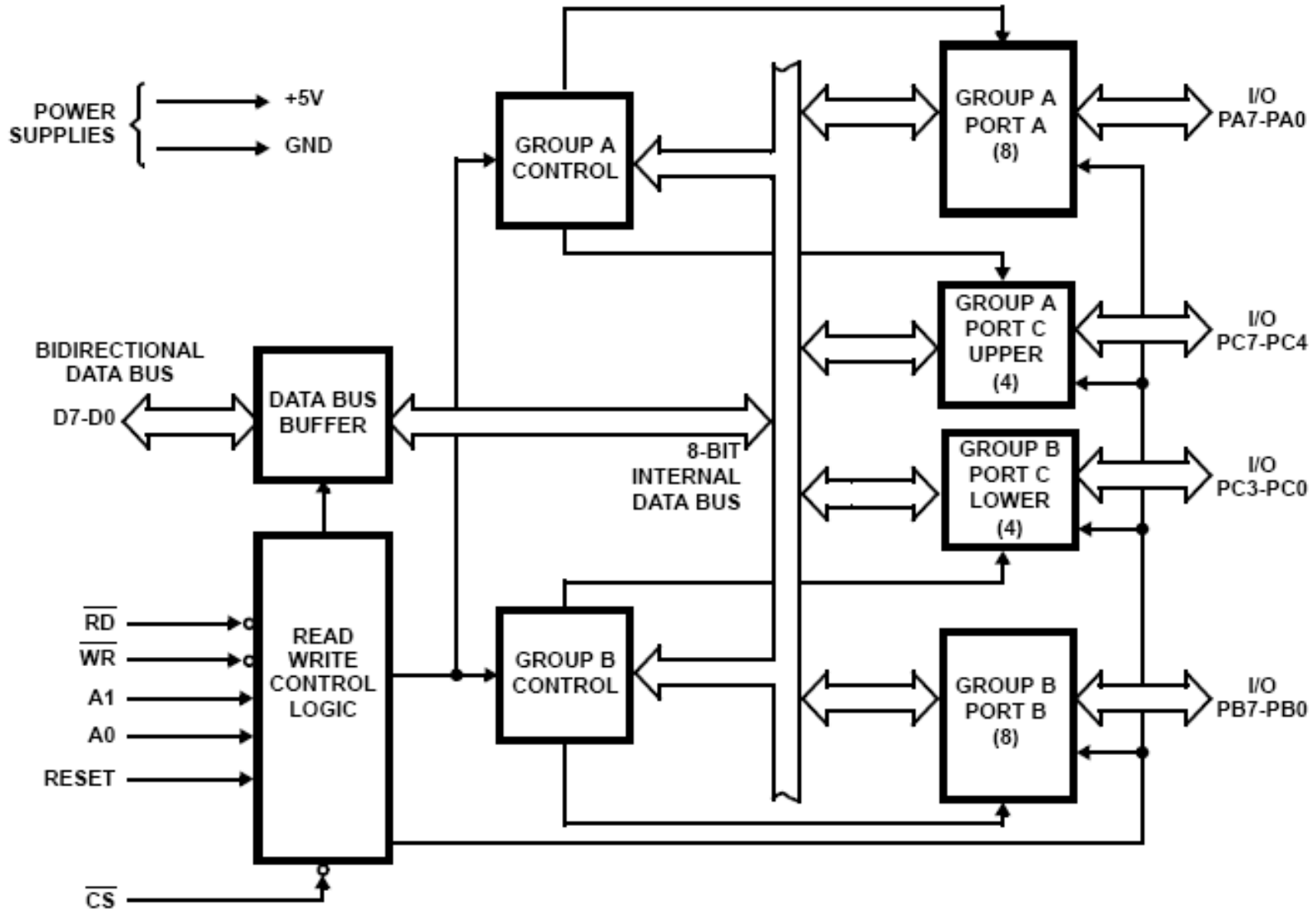

Data Bus buffer:

- ▶ **It is a 8-bit bidirectional Data bus.**
 - ▶ **Used to interface between 8255 data bus with system bus.**
 - ▶ **The internal data bus and Outer pins D_0 - D_7 pins are connected in internally.**
 - ▶ **The direction of data buffer is decided by Read/Control Logic.**
- 

Read/Write Control Logic:

- ▶ This is getting the input signals from control bus and Address bus
- ▶ Control signal are \overline{RD} and \overline{WR} .
- ▶ Address signals are A0,A1,and \overline{CS} .
- ▶ 8255 operation is enabled or disabled by \overline{CS} .

Group A and Group B control:

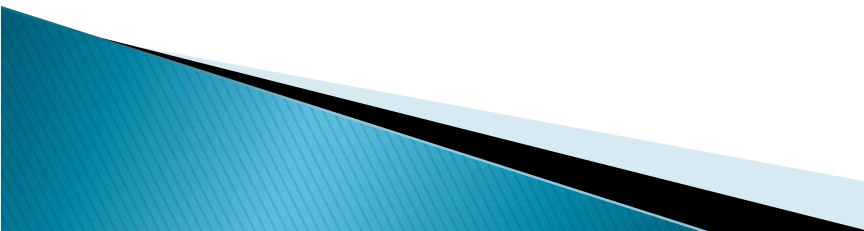
- ▶ **Group A and B get the Control Signal from CPU and send the command to the individual control blocks.**
 - **Group A send the control signal to port A and Port C (Upper) PC7-PC4.**
 - **Group B send the control signal to port B and Port C (Lower) PC3-PC0.**
- 

PORT A

- This is a 8-bit buffered I/O latch.
- It can be programmed by mode 0 , mode 1, mode 2

PORT B:

- ▶ This is a 8-bit buffer I/O latch.
- ▶ It can be programmed by mode 0 and mode 1.

▶ PORT C:

- ▶ This is a 8-bit Unlatched buffer Input and an Output latch.
- ▶ It is split into two parts.
- ▶ It can be programmed by bit set/reset operation.

Operation modes:

BIT SET/RESET MODE:

- ▶ The PORT C can be Set or Reset by sending OUT instruction to the CONTROL registers.

I/O MODES:

- ▶ MODE 0(Simple input / Output):
- ▶ In this mode , port A, port B and port C is used as individually (Simply).
- ▶ Features:
- ▶ Outputs are latched , Inputs are buffered not latched.
- ▶ Ports do not have Handshake or interrupt capability.

- ▶ **MODE 1 :(Input/output with Hand shake)**
- ▶ In this mode, input or output is transferred by hand shaking Signals.

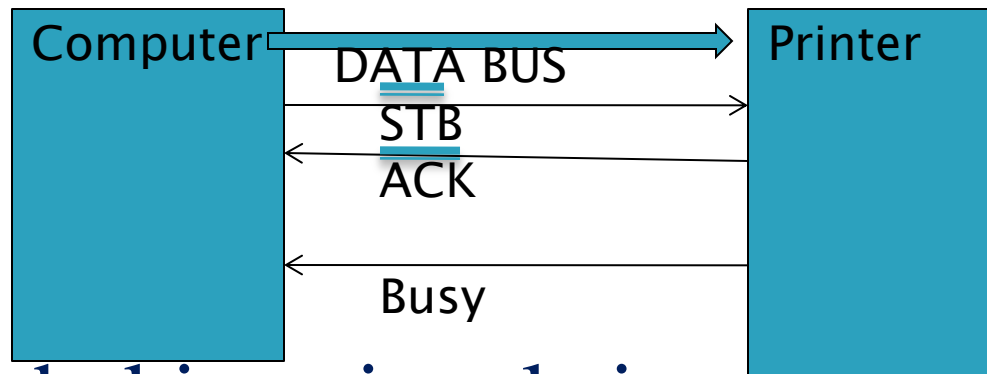

- ▶ Handshaking signals is used to transfer data between whose data transfer is not same.

▶ **Example:**

- ▶ The computer send the data to the printer large speed compared to the printer.
 - ▶ When computer send the data according to the printer speed at the time only, printer can accept.
 - ▶ If printer is not ready to accept the data then after sending the data bus , computer uses another handshaking signal to tell printer that valid data is available on the data bus.
 - ▶ Each port uses three lines from port C as handshake signals
- 

MODE 2:bi-directional I/O data transfer:

- ▶ This mode allows bidirectional data transfer over a single 8-bit data bus using handshake signals.
- ▶ This feature is possible only Group A
- ▶ Port A is working as 8-bit bidirectional.
- ▶ PC3-PC7 is used for handshaking purpose.
- ▶ The data is sent by CPU through this port, when the peripheral request it.
- ▶ CONTROL WORD FORMATS:
 - ▶ In the INPUT mode, When RESET is High all 24 pins (3-ports) be a input mode.

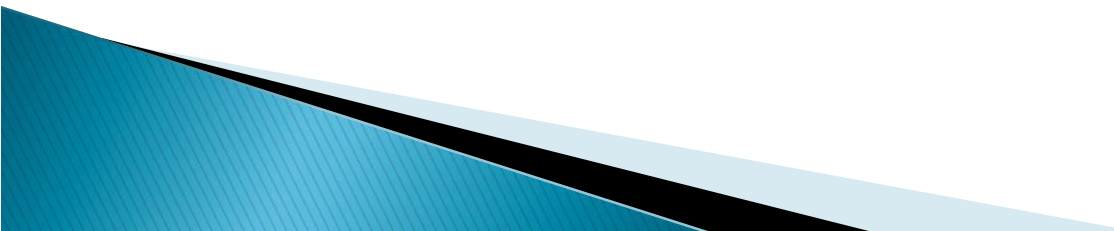
- ▶ i.e all flip flops are cleared and the interrupts are rest.
 - ▶ This condition is maintained even after RESET goes low.
 - ▶ This can be avoid by writing single control word to the control registers , when required.
- 

FOR BIT SET/RESET MODE:

- ▶ This is bit set/reset control word format.

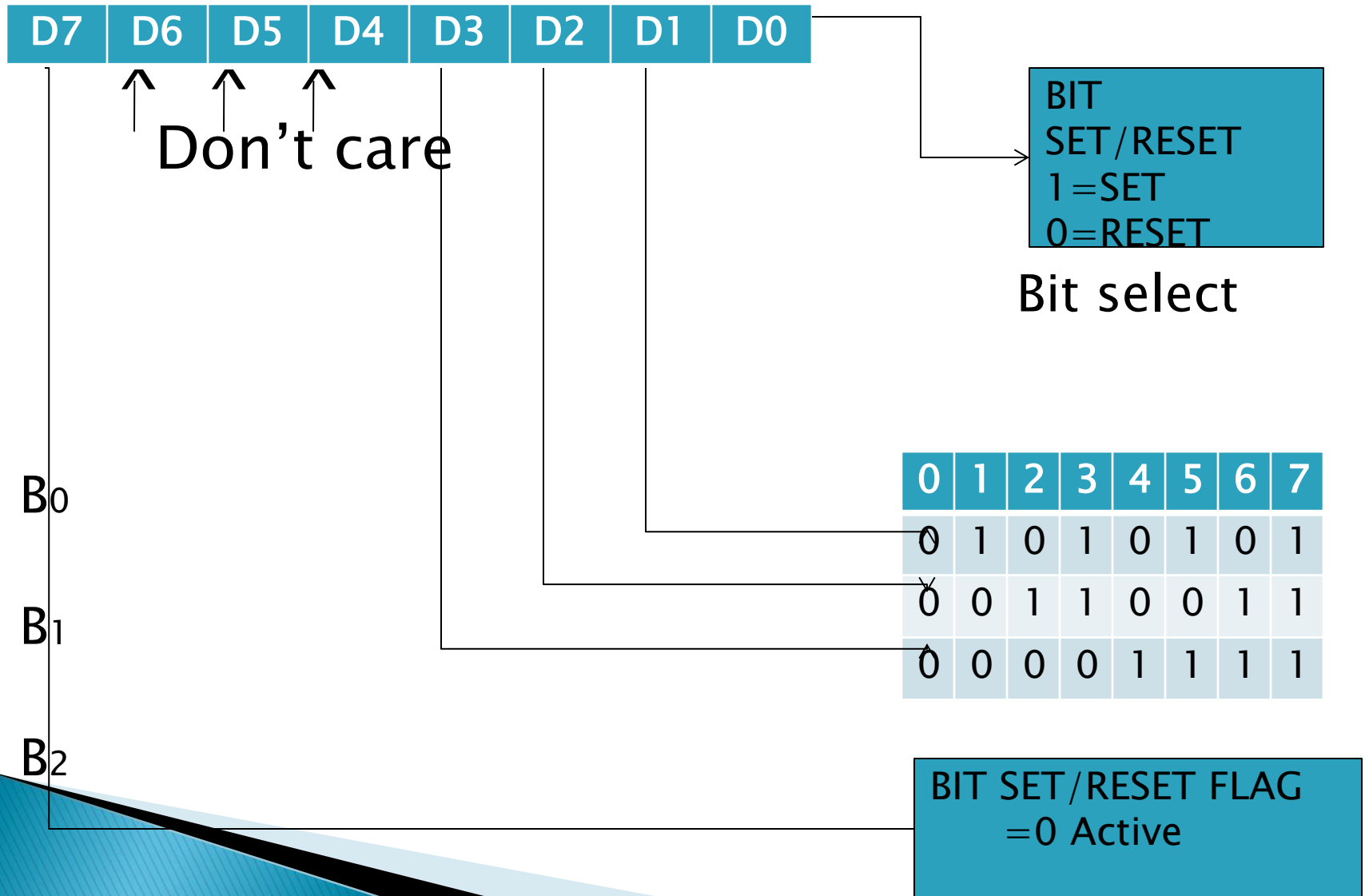

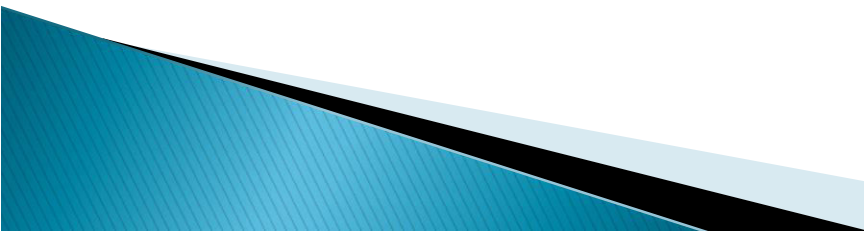
- ▶ PC0-PC7 is set or reset as per the status of D0.
 - ▶ A BSR word is written for each bit
 - ▶ Example:
 - ▶ PC3 is Set then control register will be 0XXX0111.
 - ▶ PC4 is Reset then control register will be 0XXX01000.
 - ▶ X is a don't care.
- 

▶ FOR I/O MODE:

The mode format for I/O as shown in figure

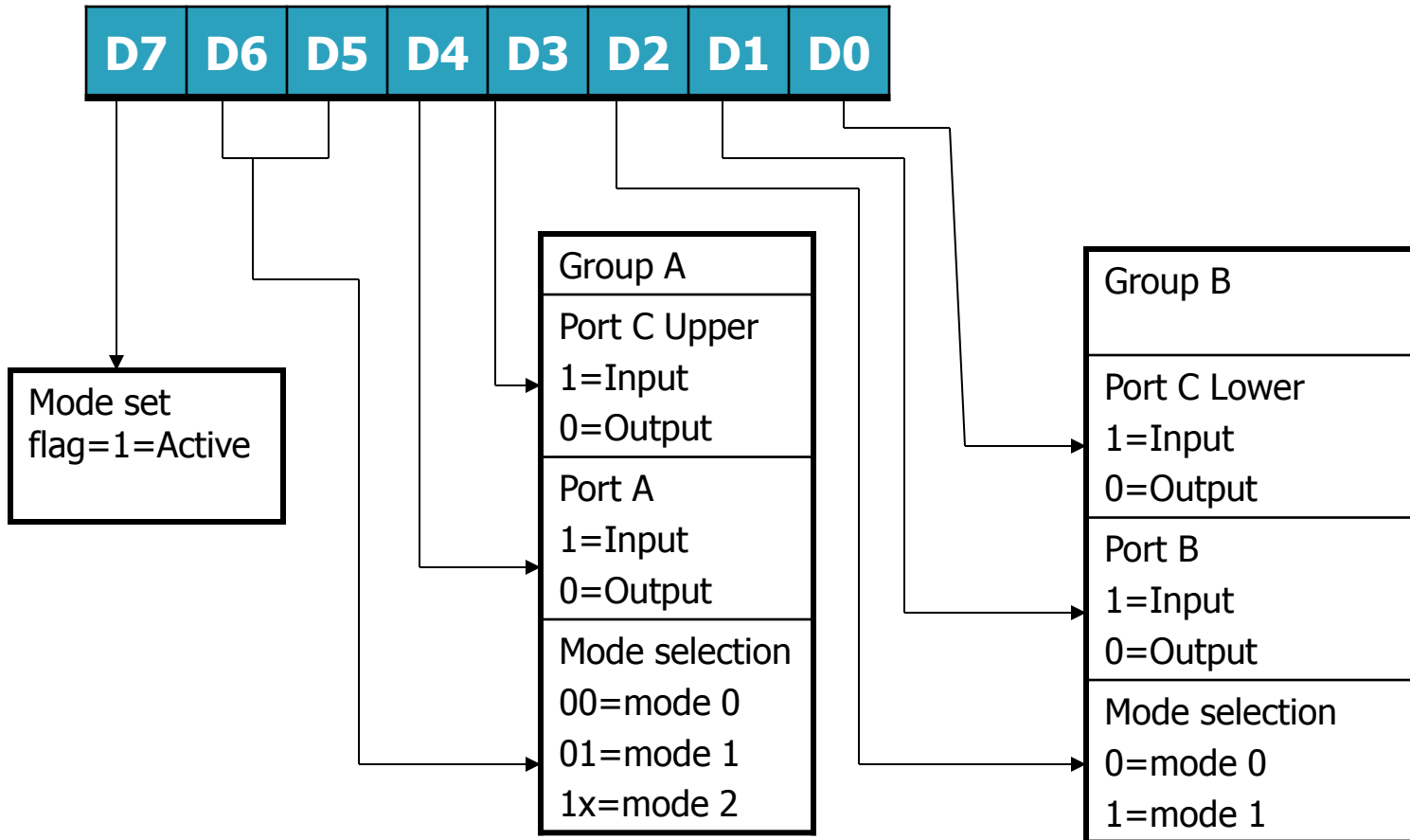

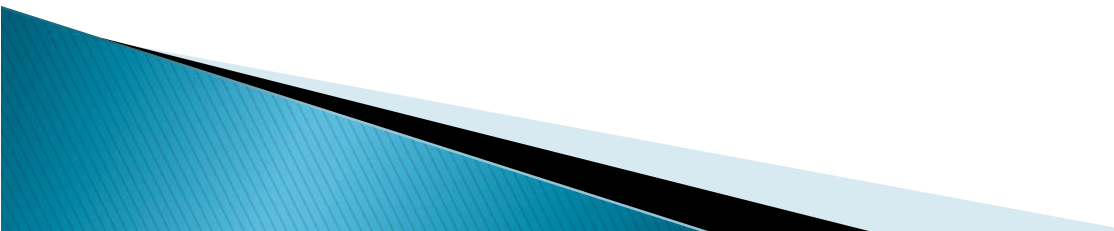
- ▶ The control word for both mode is same.
 - ▶ Bit D7 is used for specifying whether word loaded in to Bit set/reset mode or Mode definition word.
 - ▶ $D7=1$ =Mode definition mode.
 - ▶ $D7=0$ =Bit set/Reset mode.
- 

Scope of research

- ▶ Designing a device which can connect peripheral devices to the microprocessor with less hardware support and more data transfer speed.