



ELECTRONICS DEVICES AND CIRCUITS

SECTION - D

SOME SPECIAL DEVICES

OBJECTIVE

**OPTICAL EXCITATION
IN DIODE**

SOLAR CELL

1. Introduction

Solar cell: Solar cell is a photovoltaic device that converts the light energy into electrical energy based on the principles of photovoltaic effect

Photo means *light* in Greek and *Volt* is the name of a pioneer in the study of electricity Alessandro Volta

Albert Einstein was awarded the 1921 Nobel Prize in physics for his research on the photoelectric effect—a phenomenon central to the generation of electricity through solar cells.

In the early stages, the solar cell was developed only with 4 to 6 % efficiency(because of inadequate materials and problems in focusing the solar radiations). But, after 1989, the solar cells with more than 50% efficiency was developed.

Three generations of solar cells

First Generation

First generation cells consist of large-area, high quality and single junction devices.

First Generation technologies involve high energy and labour inputs which prevent any significant progress in reducing production costs.

Second Generation

Second generation materials have been developed to address energy requirements and production costs of solar cells.

Alternative manufacturing techniques such as vapour deposition and electroplating are advantageous as they reduce high temperature processing significantly

Materials for Solar cell

Solar cells are composed of various semiconducting materials

1. Crystalline silicon
2. Cadmium telluride
3. Copper indium diselenide
4. Gallium arsenide
5. Indium phosphide
6. Zinc sulphide

Note: Semiconductors are materials, which become electrically conductive when supplied with light or heat, but which operate as insulators at low temperatures

- Over 95% of all the *solar cells produced* worldwide are composed of the semiconductor material **Silicon (Si)**. As the second most abundant element in earth`s crust, silicon has the advantage, of being available in sufficient quantities.
- To produce a solar cell, the semiconductor is contaminated or "*doped*".
- "Doping" is the intentional introduction of **chemical elements** into the semiconductor.
- By doing this, depending upon the type of dopant, one can obtain a surplus of either positive charge carriers (called *p-conducting semiconductor* layer) or negative charge carriers (called *n-conducting semiconductor* layer).

- If *two differently* contaminated semiconductor *layers* are combined, then a so-called *p-n-junction results* on the boundary of the layers.

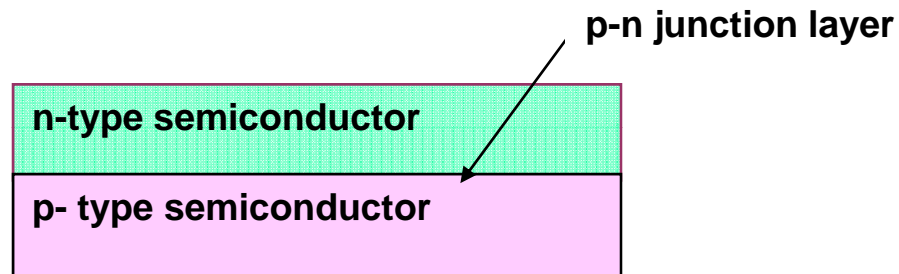

- By doping *trivalent* element, we get p-type semiconductor. (with excess amount of hole)
- By doping *pentavalent* element, we get n-type semiconductor (with excess amount of electron)

2. Photovoltaic effect

Definition:

The generation of voltage across the PN junction in a semiconductor due to the absorption of light radiation is called photovoltaic effect. The Devices based on this effect is called photovoltaic device.

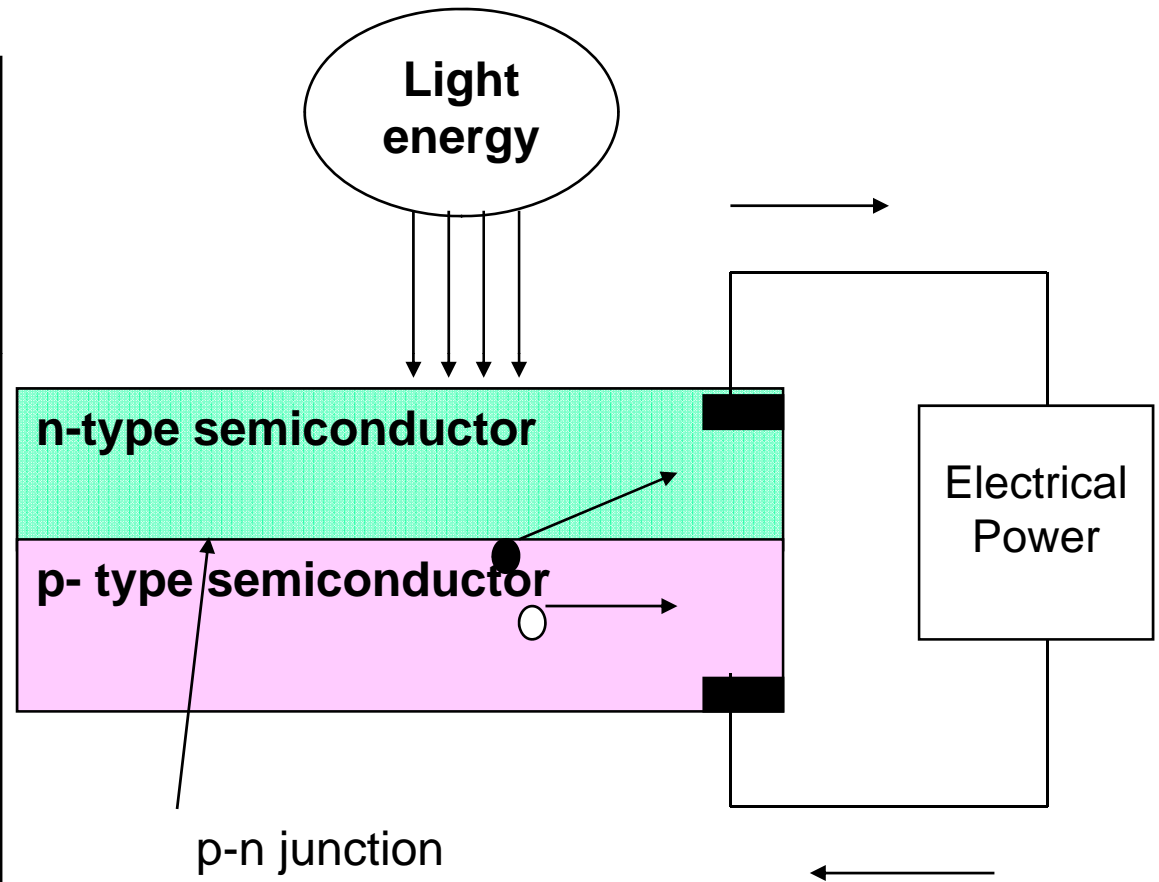

3. electron-hole formation

- Photovoltaic energy conversion relies on the number of *photons strikes on the earth*. (photon is a flux of light particles)
- On a clear day, about 4.4×10^{17} *photons* strike a square centimeter of the Earth's surface every second.
- Only some of these photons - those with *energy in excess of the band gap* - can be converted into electricity by the solar cell.
- When such photon enters the semiconductor, it may be absorbed and *promote an electron* from the valence band to the conduction band.

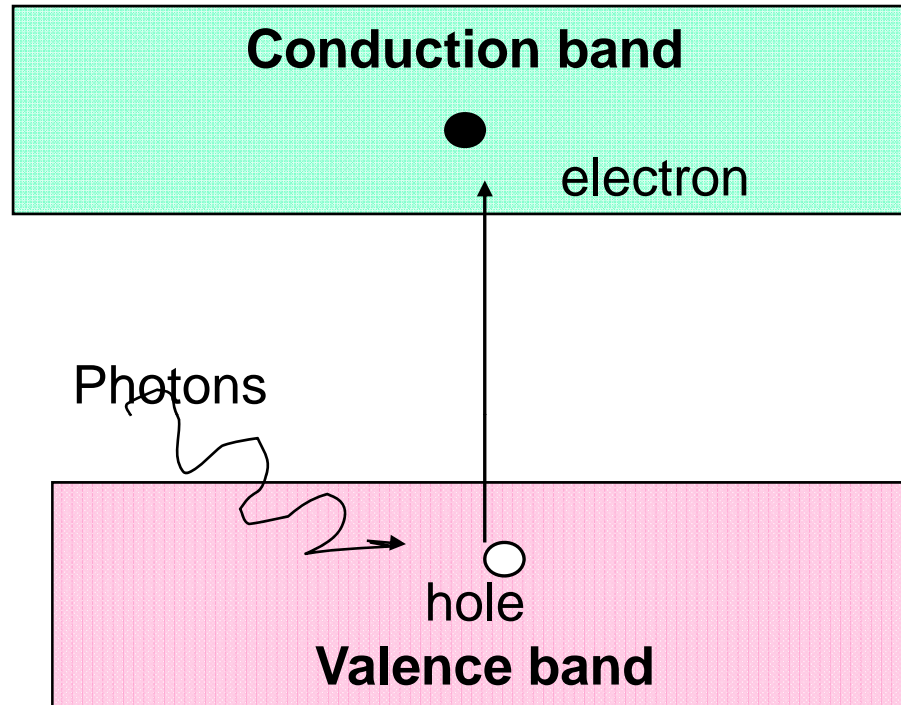

- Therefore, a *vacant is created* in the valence band and it is called hole.
- Now, the electron in the conduction band and hole in valence band *combine together* and forms *electron-hole pairs*.

4. A solar panel (or) Solar array

Single solar cell

- The single solar cell constitute the *n-type* layer *sandwiched* with *p-type* layer.
- The most *commonly* known *solar cell* is configured as a large-area p-n junction made from *silicon wafer*.
- A *single cell* can produce only very *tiny* amounts of *electricity*
- It can be used only to light up a small light bulb or power a calculator.
- Single photovoltaic cells are used in many small electronic appliances such as watches and calculators

Single Solar cell

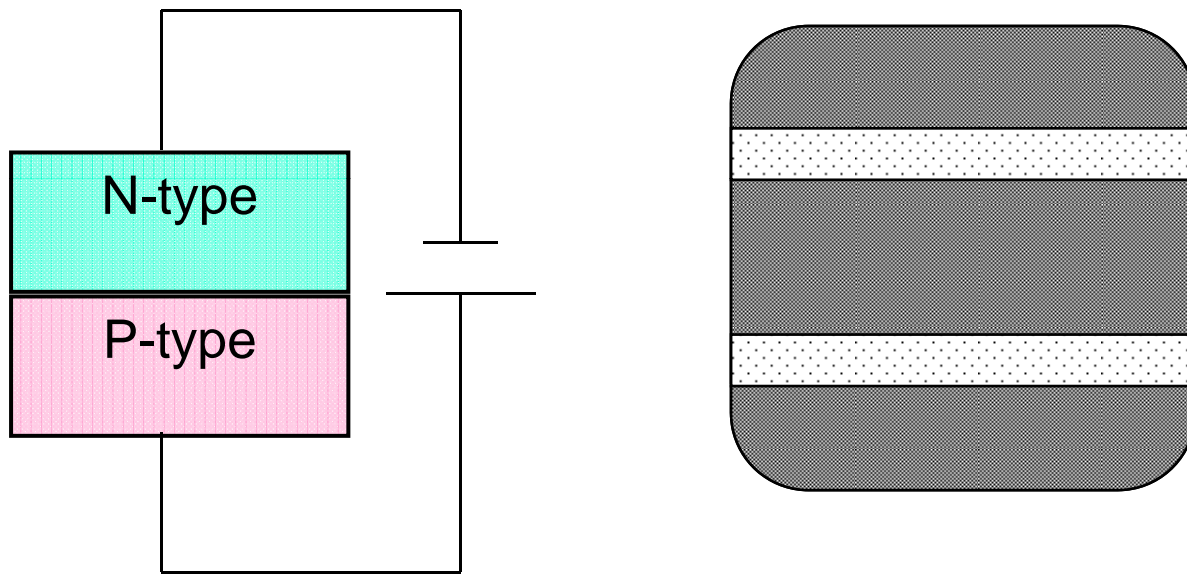

Solar panel (or) solar array (or) Solar module

The solar panel (or) solar array is the interconnection of number of solar module to get efficient power.

- A solar module consists of number of interconnected solar cells.
- These interconnected cells embedded between two glass plate to protect from the bad weather.
- Since absorption area of module is high, more energy can be produced.

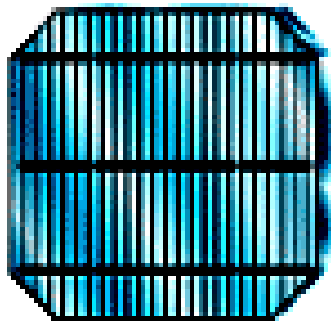

Cell

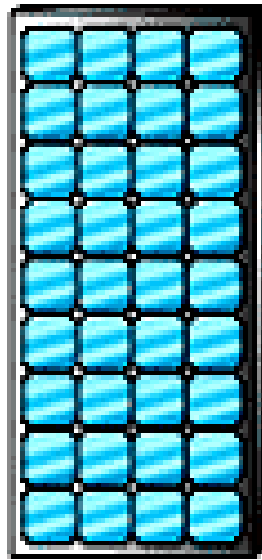

Module

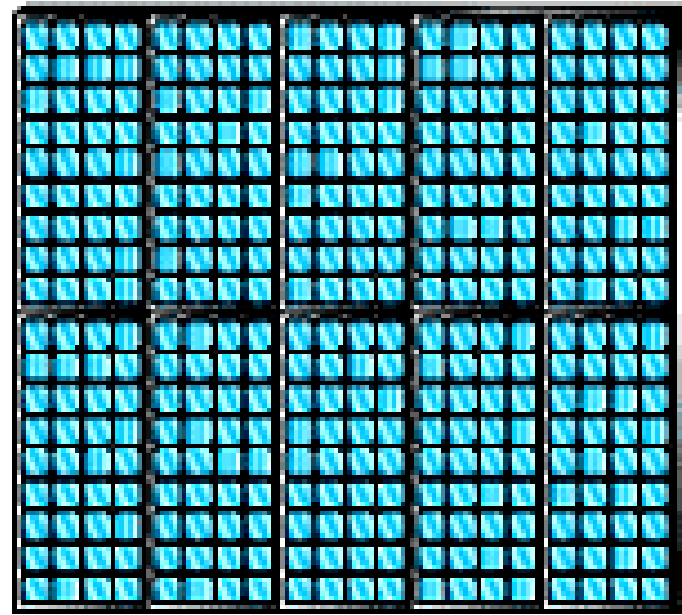

Array

5. Types of Solar cell

Based on the types of crystal used, solar cells can be classified as,

1. Monocrystalline silicon cells
2. Polycrystalline silicon cells
3. Amorphous silicon cells

1. The Monocrystalline silicon cell is produced from *pure silicon (single crystal)*. Since the Monocrystalline silicon is pure and defect free, the efficiency of cell will be higher.
2. In polycrystalline solar cell, *liquid silicon* is used as raw material and polycrystalline silicon was obtained followed by *solidification process*. The materials contain various crystalline sizes. Hence, the efficiency of this type of cell is less than Monocrystalline cell.

3. Amorphous silicon was obtained by *depositing silicon film on the substrate like glass plate.*

- The layer thickness amounts to less than $1\mu\text{m}$ – the thickness of a human hair for comparison is $50\text{-}100\mu\text{m}$.
- The efficiency of amorphous cells is much lower than that of the other two cell types.
- As a result, they are used mainly in low power equipment, such as watches and pocket calculators, or as facade elements.

Comparison of Types of solar cell

Material	Efficiency (%)
Monocrystalline silicon	14-17
Polycrystalline silicon	13-15
Amorphous silicon	5-7

6. Principle, construction and working of Solar cell

Principle: The solar cells are based on the principles of photovoltaic effect. The **photovoltaic effect** is the photogeneration of charge carriers in a light absorbing materials as a result of absorption of light radiation.

Construction

- Solar cell (crystalline Silicon) consists of a ***n-type semiconductor (emitter)*** layer and ***p-type semiconductor layer (base)***. The two layers are sandwiched and hence there is formation of p-n ***junction***.
- The surface is coated with ***anti-reflection coating*** to avoid the loss of incident light energy due to reflection.

Parameters of solar cell

- Open circuit voltage, **Voc**
- Short circuit current, **Isc**
- Ideal Power, **$P_{ideal} = I_{sc} \times V_{oc}$**
- Maximum Power, **$P_{max} = I_m \times V_m$**
- Fill factor – ratio of the maximum useful power to the ideal power

i.e.

$$F.F. = \frac{I_m \times V_m}{I_{sc} \times V_{oc}}$$